



Circuit breaker size S0 for motor protection, CLASS 10 A-release 34...40 A N-release 480 A screw terminal Standard switching capacity

<b>product brand name</b>	SIRIUS
<b>product designation</b>	Circuit breaker
<b>design of the product</b>	For motor protection
<b>product type designation</b>	3RV2
<b>General technical data</b>	
<b>size of the circuit-breaker</b>	S0
<b>size of contactor can be combined company-specific</b>	S00, S0
product extension auxiliary switch	Yes
<b>power loss [W] for rated value of the current</b>	
• at AC in hot operating state	16.25 W
• at AC in hot operating state per pole	5.4 W
insulation voltage with degree of pollution 3 at AC rated value	690 V
<b>surge voltage resistance rated value</b>	6 kV
<b>shock resistance according to IEC 60068-2-27</b>	25g / 11 ms
<b>mechanical service life (operating cycles)</b>	
• of the main contacts typical	100 000
• of auxiliary contacts typical	100 000
electrical endurance (operating cycles) typical	100 000
<b>type of protection according to ATEX directive 2014/34/EU</b>	Ex II (2) GD
certificate of suitability according to ATEX directive 2014/34/EU	DMT 02 ATEX F 001
<b>reference code according to IEC 81346-2</b>	Q
<b>Substance Prohibitance (Date)</b>	10/01/2009
<b>Ambient conditions</b>	
installation altitude at height above sea level maximum	2 000 m
<b>ambient temperature</b>	
• during operation	-20 ... +40 °C
• during storage	-50 ... +80 °C
• during transport	-50 ... +80 °C
relative humidity during operation	10 ... 95 %
<b>Main circuit</b>	
<b>number of poles for main current circuit</b>	3
<b>adjustable current response value current of the current-dependent overload release</b>	34 ... 40 A
<b>operating voltage</b>	
• rated value	20 ... 690 V
• at AC-3 rated value maximum	690 V
<b>operating frequency rated value</b>	50 ... 60 Hz
<b>operational current rated value</b>	40 A
<b>operational current</b>	
• at AC-3 at 400 V rated value	40 A

<b>operating power</b>	
<ul style="list-style-type: none"> <li>● at AC-3 <ul style="list-style-type: none"> <li>— at 230 V rated value</li> <li>— at 400 V rated value</li> <li>— at 500 V rated value</li> <li>— at 690 V rated value</li> </ul> </li> </ul>	11 kW 18.5 kW 22 kW 39 kW
<b>operating frequency</b>	
<ul style="list-style-type: none"> <li>● at AC-3 maximum</li> </ul>	15 1/h
<b>Auxiliary circuit</b>	
<b>number of NC contacts for auxiliary contacts</b>	0
<b>number of NO contacts for auxiliary contacts</b>	0
number of CO contacts for auxiliary contacts	0
<b>Protective and monitoring functions</b>	
<b>product function</b>	
<ul style="list-style-type: none"> <li>● ground fault detection</li> <li>● phase failure detection</li> </ul>	No Yes
<b>trip class</b>	CLASS 10
<b>design of the overload release</b>	thermal
<b>maximum short-circuit current breaking capacity (Icu)</b>	
<ul style="list-style-type: none"> <li>● at AC at 240 V rated value</li> <li>● at AC at 400 V rated value</li> <li>● at AC at 500 V rated value</li> <li>● at AC at 690 V rated value</li> </ul>	100 kA 20 kA 6 kA 3 kA
<b>operating short-circuit current breaking capacity (Ics) at AC</b>	
<ul style="list-style-type: none"> <li>● at 240 V rated value</li> <li>● at 400 V rated value</li> <li>● at 500 V rated value</li> <li>● at 690 V rated value</li> </ul>	100 kA 10 kA 3 kA 2 kA
response value current of instantaneous short-circuit trip unit	480 A
<b>UL/CSA ratings</b>	
<b>full-load current (FLA) for 3-phase AC motor</b>	
<ul style="list-style-type: none"> <li>● at 480 V rated value</li> <li>● at 600 V rated value</li> </ul>	40 A 40 A
<b>yielded mechanical performance [hp]</b>	
<ul style="list-style-type: none"> <li>● for single-phase AC motor <ul style="list-style-type: none"> <li>— at 110/120 V rated value</li> <li>— at 230 V rated value</li> </ul> </li> <li>● for 3-phase AC motor <ul style="list-style-type: none"> <li>— at 200/208 V rated value</li> <li>— at 220/230 V rated value</li> <li>— at 460/480 V rated value</li> </ul> </li> </ul>	3 hp 7.5 hp 10 hp 10 hp 30 hp
<b>Short-circuit protection</b>	
<b>product function short circuit protection</b>	Yes
<b>design of the short-circuit trip</b>	magnetic
<b>design of the fuse link for IT network for short-circuit protection of the main circuit</b>	
<ul style="list-style-type: none"> <li>● at 400 V</li> <li>● at 500 V</li> <li>● at 690 V</li> </ul>	gG 63 A gG 63 A gG 63 A
<b>Installation/ mounting/ dimensions</b>	
<b>mounting position</b>	any
<b>fastening method</b>	screw and snap-on mounting onto 35 mm DIN rail according to DIN EN 60715
<b>height</b>	97 mm
<b>width</b>	45 mm
<b>depth</b>	97 mm
<b>required spacing</b>	
<ul style="list-style-type: none"> <li>● with side-by-side mounting at the side</li> <li>● for grounded parts at 400 V <ul style="list-style-type: none"> <li>— downwards</li> <li>— upwards</li> <li>— at the side</li> </ul> </li> </ul>	9 mm 30 mm 30 mm 9 mm

<ul style="list-style-type: none"> <li>● for live parts at 400 V <ul style="list-style-type: none"> <li>— downwards</li> <li>— upwards</li> <li>— at the side</li> </ul> </li> <li>● for grounded parts at 500 V <ul style="list-style-type: none"> <li>— downwards</li> <li>— upwards</li> <li>— at the side</li> </ul> </li> <li>● for live parts at 500 V <ul style="list-style-type: none"> <li>— downwards</li> <li>— upwards</li> <li>— at the side</li> </ul> </li> <li>● for grounded parts at 690 V <ul style="list-style-type: none"> <li>— downwards</li> <li>— upwards</li> <li>— backwards</li> <li>— at the side</li> <li>— forwards</li> </ul> </li> <li>● for live parts at 690 V <ul style="list-style-type: none"> <li>— downwards</li> <li>— upwards</li> <li>— backwards</li> <li>— at the side</li> <li>— forwards</li> </ul> </li> </ul>	30 mm 30 mm 9 mm  30 mm 30 mm 9 mm  30 mm 30 mm 9 mm  70 mm 70 mm 0 mm 30 mm 0 mm  70 mm 70 mm 0 mm 30 mm 0 mm
--	--

#### Connections/ Terminals

<b>type of electrical connection</b>	
<ul style="list-style-type: none"> <li>● for main current circuit</li> </ul>	screw-type terminals
<b>arrangement of electrical connectors for main current circuit</b>	Top and bottom
<b>type of connectable conductor cross-sections</b>	
<ul style="list-style-type: none"> <li>● for main contacts <ul style="list-style-type: none"> <li>— solid or stranded</li> <li>— finely stranded with core end processing</li> </ul> </li> <li>● for AWG cables for main contacts</li> </ul>	2x (1 ... 2.5 mm <sup>2</sup> ), 2x (2.5 ... 10 mm <sup>2</sup> ) 2x (1 ... 2.5 mm <sup>2</sup> ), 2x (2.5 ... 6 mm <sup>2</sup> ), 1x 10 mm <sup>2</sup> 2x (16 ... 12), 2x (14 ... 8)
<b>tightening torque</b>	
<ul style="list-style-type: none"> <li>● for main contacts with screw-type terminals</li> </ul>	2 ... 2.5 N·m
<b>design of screwdriver shaft</b>	Diameter 5 to 6 mm
<b>size of the screwdriver tip</b>	Pozidriv size 2
<b>design of the thread of the connection screw</b>	
<ul style="list-style-type: none"> <li>● for main contacts</li> </ul>	M4

#### Safety related data

<b>B10 value</b>	
<ul style="list-style-type: none"> <li>● with high demand rate according to SN 31920</li> </ul>	5 000
<b>proportion of dangerous failures</b>	
<ul style="list-style-type: none"> <li>● with low demand rate according to SN 31920</li> <li>● with high demand rate according to SN 31920</li> </ul>	50 % 50 %
<b>failure rate [FIT]</b>	
<ul style="list-style-type: none"> <li>● with low demand rate according to SN 31920</li> </ul>	50 FIT
T1 value for proof test interval or service life according to IEC 61508	10 a
<b>protection class IP on the front according to IEC 60529</b>	IP20
<b>touch protection on the front according to IEC 60529</b>	finger-safe, for vertical contact from the front
display version for switching status	Handle

#### Certificates/ approvals

General Product Approval

For use in hazardous locations













Confirmation



KC



For use in hazardous locations	Declaration of Conformity	Test Certificates		Marine / Shipping
			<a href="#">Type Test Certificates/Test Report</a>	<a href="#">Special Test Certificate</a>
		EG-Konf.		
Marine / Shipping				other
				
				<a href="#">Confirmation</a>
other	Railway			
	<a href="#">Confirmation</a>	<a href="#">Vibration and Shock</a>		

#### Further information

Siemens has decided to exit the Russian market (see here).

<https://press.siemens.com/global/en/pressrelease/siemens-wind-down-russian-business>

Siemens is working on the renewal of the current EAC certificates.

Please contact your local Siemens office on the status of validity of the EAC certification if you intend to import or offer to supply these products to an EAC relevant market (other than the sanctioned EAEU member states Russia or Belarus).

Information on the packaging

<https://support.industry.siemens.com/cs/ww/en/view/109813875>

Information- and Downloadcenter (Catalogs, Brochures,...)

<https://www.siemens.com/ic10>

Industry Mall (Online ordering system)

<https://mall.industry.siemens.com/mall/en/en/Catalog/product?mlfb=3RV2021-4FA10>

Cax online generator

<http://support.automation.siemens.com/WW/CAXorder/default.aspx?lang=en&mlfb=3RV2021-4FA10>

Service&Support (Manuals, Certificates, Characteristics, FAQs,...)

<https://support.industry.siemens.com/cs/ww/en/ps/3RV2021-4FA10>

Image database (product images, 2D dimension drawings, 3D models, device circuit diagrams, EPLAN macros, ...)

[http://www.automation.siemens.com/bilddb/cax\\_de.aspx?mlfb=3RV2021-4FA10&lang=en](http://www.automation.siemens.com/bilddb/cax_de.aspx?mlfb=3RV2021-4FA10&lang=en)

Characteristic: Tripping characteristics, I<sup>2</sup>t, Let-through current

<https://support.industry.siemens.com/cs/ww/en/ps/3RV2021-4FA10/char>

Further characteristics (e.g. electrical endurance, switching frequency)

<http://www.automation.siemens.com/bilddb/index.aspx?view=Search&mlfb=3RV2021-4FA10&objecttype=14&gridview=view1>

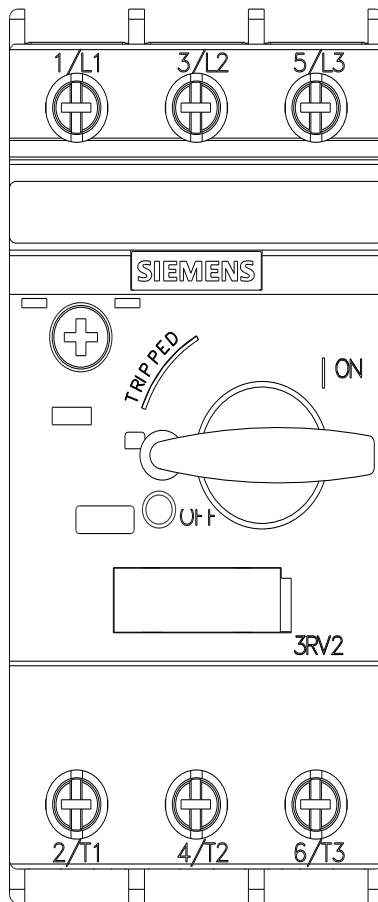



last modified:

11/21/2022 