

PC 4/ 2-G-7,62 - PCB header

1804797

<https://www.phoenixcontact.com/us/products/1804797>

Please be informed that the data shown in this PDF document is generated from our Online Catalog. Please find the complete data in the user documentation. Our General Terms of Use for Downloads are valid.



PCB headers, nominal cross section: 4 mm², color: green, nominal current: 20 A, rated voltage (III/2): 630 V, contact surface: Tin, type of contact: Pin, number of potentials: 2, number of rows: 1, number of positions: 2, number of connections: 2, product range: PC 4/..-G, pitch: 7.62 mm, mounting: Wave soldering, pin layout: Linear pinning, solder pin [P]: 5 mm, number of solder pins per potential: 2, plug-in system: COMBICON PC 4, Pin connector pattern alignment: Standard, locking: without, mounting: without, type of packaging: packed in cardboard, Mounting flange: Accessory Item No. 1827570

Your advantages

- Well-known mounting principle allows worldwide use

Commercial Data

Item number	1804797
Packing unit	1 pc
Minimum order quantity	50 pc
Sales Key	AA04
Product Key	AADSAA
Catalog Page	Page 516 (C-1-2013)
GTIN	4017918046231
Weight per Piece (including packing)	4.311 g
Weight per Piece (excluding packing)	3.5 g
Customs tariff number	85366930
Country of origin	BG

PC 4/ 2-G-7,62 - PCB header



1804797

<https://www.phoenixcontact.com/us/products/1804797>

Technical Data

Product properties

Type	Standard
Product line	COMBICON Connectors L
Product type	PCB headers
Product family	PC 4/..-G
Number of positions	2
Pitch	7.62 mm
Number of connections	2
Number of rows	1
Mounting flange	without
Number of potentials	2
Pin layout	Linear pinning
Solder pins per potential	2

Electrical properties

Nominal current I_N	20 A
Nominal voltage U_N	630 V
Degree of pollution	3
Contact resistance	0.5 m Ω
Rated voltage (III/3)	400 V
Rated surge voltage (III/3)	6 kV
Rated voltage (III/2)	630 V
Rated surge voltage (III/2)	6 kV
Rated voltage (II/2)	630 V
Rated surge voltage (II/2)	6 kV

Mounting

Mounting type	Wave soldering
Pin layout	Linear pinning

Material specifications

Material data - contact

Note	WEEE/RoHS-compliant, free of whiskers according to IEC 60068-2-82/JEDEC JESD 201
Contact material	Cu alloy
Surface characteristics	Tin-plated
Metal surface contact area (top layer)	Tin (5 - 7 μm Sn)
Metal surface contact area (middle layer)	Nickel (2 - 5 μm Ni)
Metal surface soldering area (top layer)	Tin (5 - 7 μm Sn)
Metal surface soldering area (middle layer)	Nickel (2 - 5 μm Ni)

Material data - housing

PC 4/ 2-G-7,62 - PCB header

1804797

<https://www.phoenixcontact.com/us/products/1804797>

Color (Housing)	green (6021)
Insulating material	PA
Insulating material group	I
CTI according to IEC 60112	600
Flammability rating according to UL 94	V0
Glow wire flammability index GWFI according to EN 60695-2-12	850
Glow wire ignition temperature GWIT according to EN 60695-2-13	775
Temperature for the ball pressure test according to EN 60695-10-2	125 °C

Material data – actuating element

Color ()	()
----------	----

Notes

Notes on operation	In accordance with IEC 61984, COMBICON connectors have no switching power (COC). During designated use, they must not be plugged in or disconnected when carrying voltage or under load.
--------------------	--

Dimensions

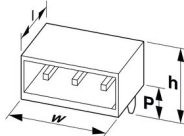
Dimensional drawing	
Pitch	7.62 mm
Width [w]	15.22 mm
Height [h]	19.25 mm
Length [l]	29 mm
Installed height	14.25 mm
Solder pin length [P]	5 mm

Mechanical tests

Test for conductor damage and slackening

Specification	IEC 60999-1:1999-11
Result	Test passed

Pull-out test

Specification	IEC 60999-1:1999-11
Conductor cross section/conductor type/tractive force setpoint/actual value	0.2 mm ² / solid / > 10 N
	0.2 mm ² / flexible / > 10 N
	4 mm ² / solid / > 60 N
	4 mm ² / flexible / > 60 N

Insertion and withdrawal forces

Result	Test passed
--------	-------------

PC 4/ 2-G-7,62 - PCB header



1804797

<https://www.phoenixcontact.com/us/products/1804797>

No. of cycles	50
Insertion strength per pos. approx.	8 N
Withdraw strength per pos. approx.	5 N

Torque test

Specification	IEC 60999-1:1999-11
---------------	---------------------

Contact holder in insert

Specification	IEC 60512-15-1:2008-05
Contact holder in insert Requirements >20 N	Test passed

Resistance of inscriptions

Specification	IEC 60068-2-70:1995-12
Result	Test passed

Polarization and coding

Specification	IEC 60512-13-5:2006-02
Result	Test passed

Visual inspection

Specification	IEC 60512-1-1:2002-02
Result	Test passed

Dimension check

Specification	IEC 60512-1-2:2002-02
Result	Test passed

Electrical tests

Thermal test | Test group C

Specification	IEC 60512-5-1:2002-02
Tested number of positions	12

Insulation resistance

Specification	IEC 60512-3-1:2002-02
Insulation resistance, neighboring positions	> 5 MΩ

Air clearances and creepage distances |

Specification	IEC 60664-1:2007-04
Insulating material group	I
Comparative tracking index (IEC 60112)	CTI 600
Rated insulation voltage (III/3)	400 V
Rated surge voltage (III/3)	6 kV
minimum clearance value - non-homogenous field (III/3)	5.5 mm
minimum creepage distance (III/3)	5.5 mm
Rated insulation voltage (III/2)	630 V
Rated surge voltage (III/2)	6 kV

PC 4/ 2-G-7,62 - PCB header



1804797

<https://www.phoenixcontact.com/us/products/1804797>

minimum clearance value - non-homogenous field (III/2)	5.5 mm
minimum creepage distance (III/2)	5.5 mm
Rated insulation voltage (II/2)	630 V
Rated surge voltage (II/2)	6 kV
minimum clearance value - non-homogenous field (II/2)	5.5 mm
minimum creepage distance (II/2)	5.5 mm

Environmental and real-life conditions

Vibration test

Specification	IEC 60068-2-6:2007-12
Frequency	10 - 150 - 10 Hz
Sweep speed	1 octave/min
Amplitude	0.35 mm (10 Hz ... 60.1 Hz)
Sweep speed	5g (60.1 Hz ... 150 Hz)
Test duration per axis	2.5 h

Durability test

Specification	IEC 60512-9-1:2010-03
Impulse withstand voltage at sea level	7.3 kV
Contact resistance R_1	0.5 m Ω
Contact resistance R_2	0.6 m Ω
Insertion/withdrawal cycles	50

Climatic test

Specification	ISO 6988:1985-02
Corrosive stress	0.2 dm ³ SO ₂ on 300 dm ³ /40 °C/1 cycle
Thermal stress	100 °C/168 h
Power-frequency withstand voltage	3.31 kV

Ambient conditions

Ambient temperature (operation)	-40 °C ... 100 °C (dependent on the derating curve)
Ambient temperature (storage/transport)	-40 °C ... 70 °C
Relative humidity (storage/transport)	30 % ... 70 %
Ambient temperature (assembly)	-5 °C ... 100 °C

Packaging specifications

Type of packaging	packed in cardboard
-------------------	---------------------

Drawings

Diagram

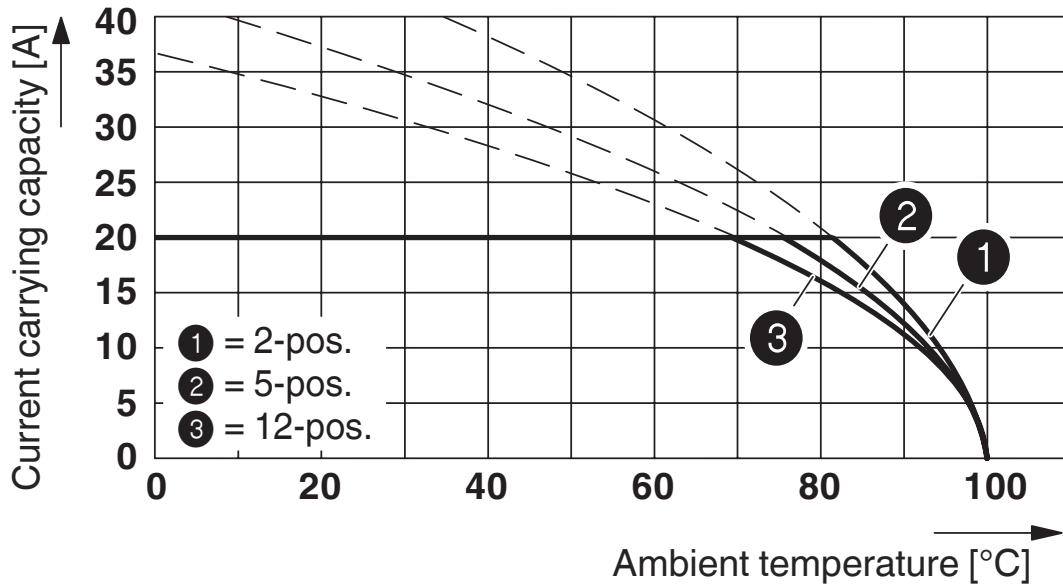

Type: PC 4/...-ST-7,62 with PC 4/...-G-7,62

Diagram

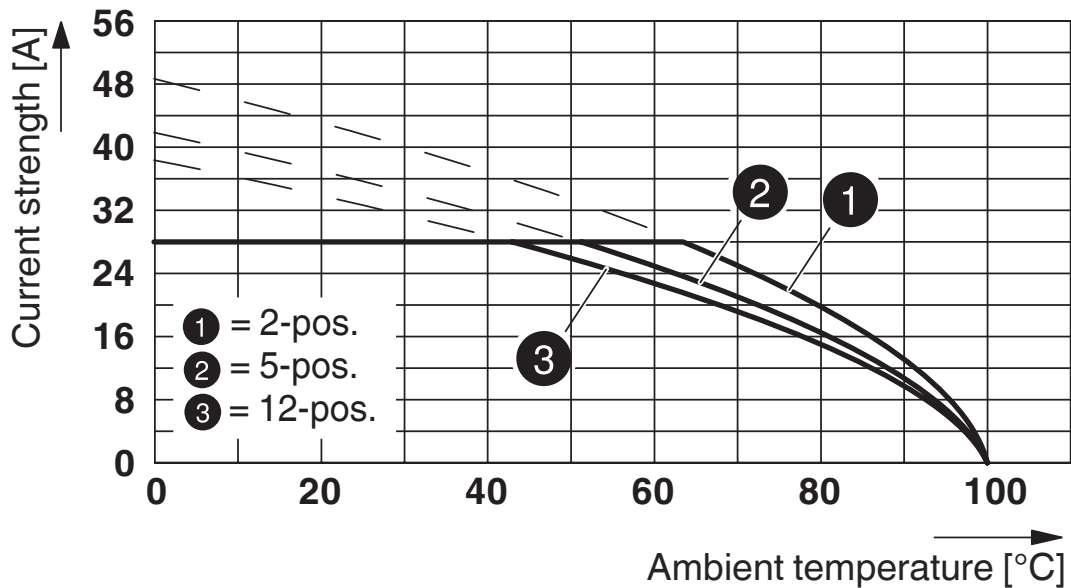

Type: PC 5/...-STF1-7,62 with PC 4/...-G-7,62 and BF-PC 4
 Conductor cross section: 4 mm²

Drilling plan/solder pad geometry

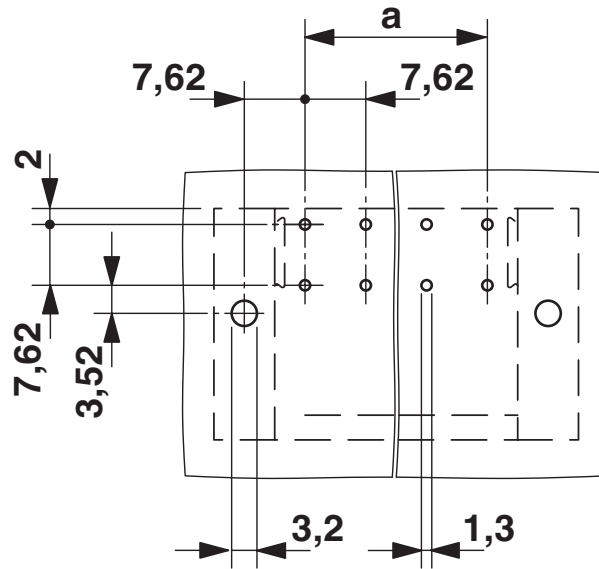

Dimensional drawing

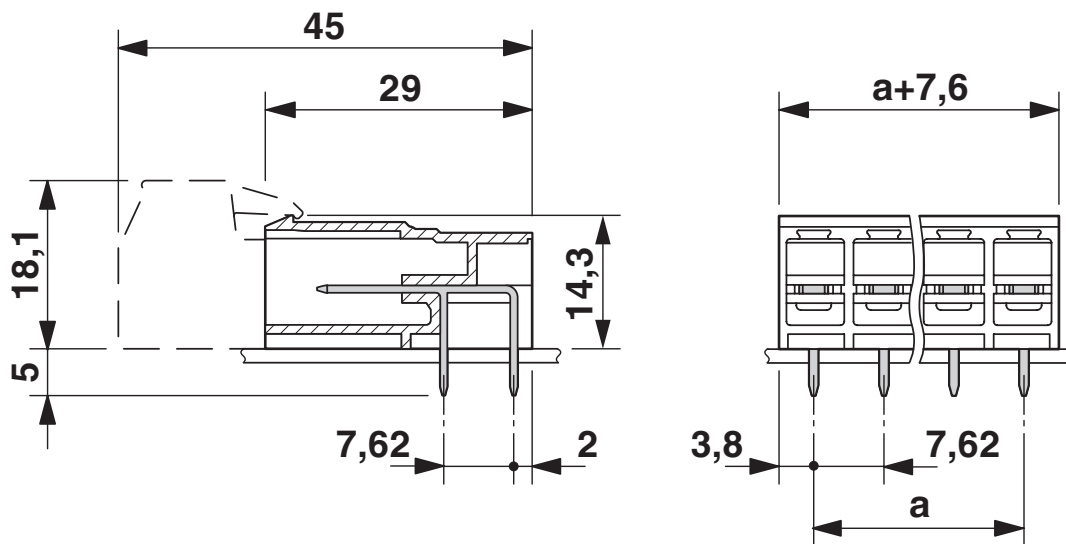

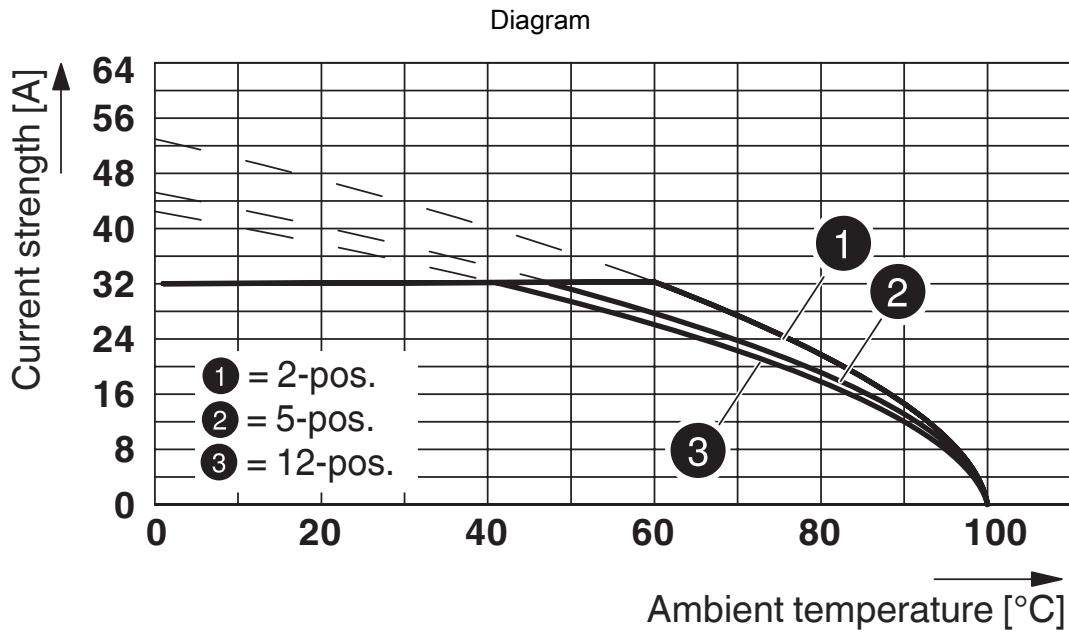

Derating curve for: PC 5/...-ST1-7,62 with PC 4/...-G-7,62
 Conductor cross section: 6 mm²

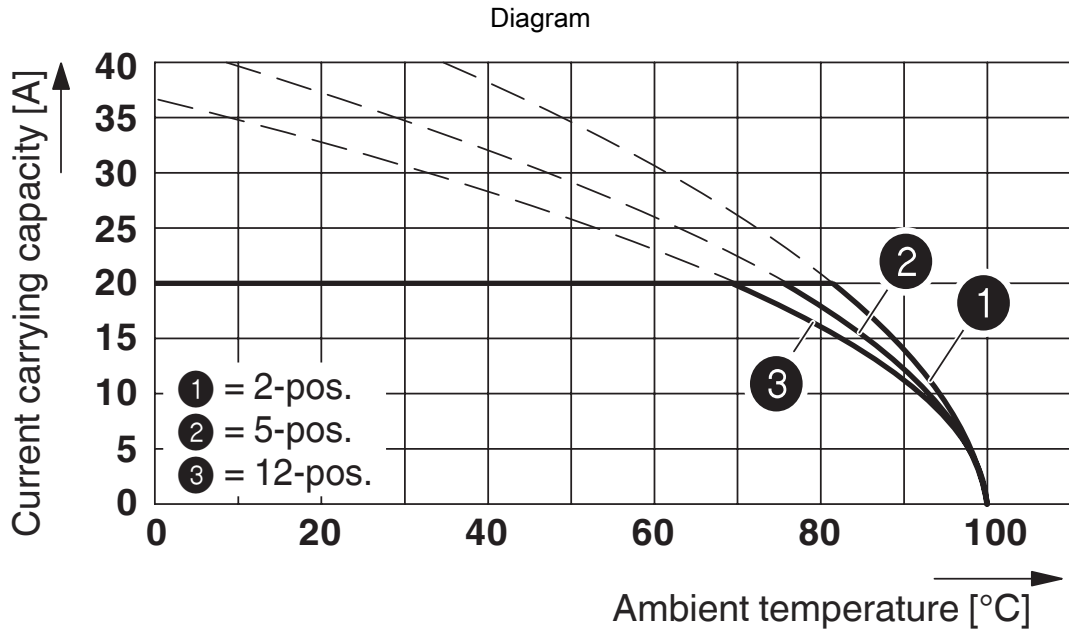

Type: PC 4/...-STF-7,62 with PC 4/...-G-7,62 and BF-PC 4

1804797

<https://www.phoenixcontact.com/us/products/1804797>



Type: PC 5/...-ST2-7,62 with PC 4/...-G-7,62

Conductor cross section: 4 mm²

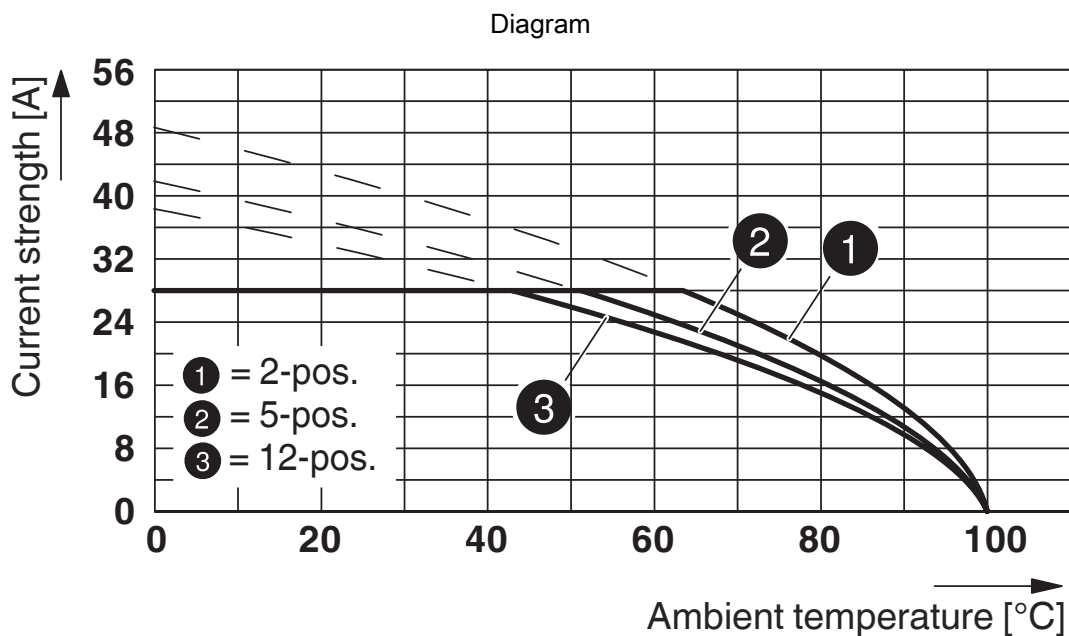

Derating curve for: PC 5/...-ST1-7,62 with PC 4/...-G-7,62

Conductor cross section: 4 mm²

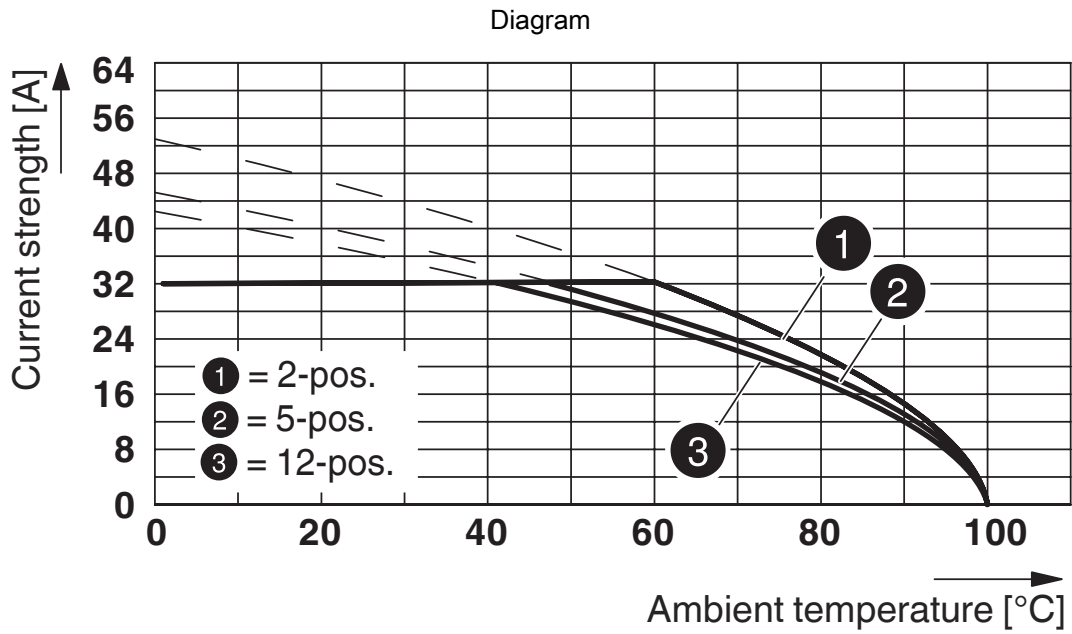

Type: PC 5/...-ST2-7,62 with PC 4/...-G-7,62

Conductor cross section: 6 mm²

PC 4/ 2-G-7,62 - PCB header



1804797

<https://www.phoenixcontact.com/us/products/1804797>

Approvals

 CSA Approval ID: 13631				
	Nominal Voltage U_N	Nominal Current I_N	Cross Section AWG	Cross Section mm^2
	300 V	20 A	-	-
	300 V	20 A	-	-

 EAC Approval ID: B.01687				
--	--	--	--	--

 cULus Recognized Approval ID: E60425-19920722				
	Nominal Voltage U_N	Nominal Current I_N	Cross Section AWG	Cross Section mm^2
	300 V	30 A	-	-
	300 V	30 A	-	-

 DNV GL Approval ID: TAE00001EZ				
--	--	--	--	--

 LR Approval ID: LR21308805TA				
--	--	--	--	--

 BV Approval ID: 35433/B0 BV				
---	--	--	--	--

PC 4/ 2-G-7,62 - PCB header



1804797

<https://www.phoenixcontact.com/us/products/1804797>

Classifications

ECLASS

ECLASS-11.0	27460201
ECLASS-12.0	27460201
ECLASS-13.0	27460201

ETIM

ETIM 8.0	EC002637
----------	----------

UNSPSC

UNSPSC 21.0	39121400
-------------	----------

PC 4/ 2-G-7,62 - PCB header

1804797

<https://www.phoenixcontact.com/us/products/1804797>



Environmental Product Compliance

China RoHS	Environmentally friendly use period: unlimited = EFUP-e
	No hazardous substances above threshold values

PC 4/ 2-G-7,62 - PCB header

1804797

<https://www.phoenixcontact.com/us/products/1804797>

Accessories

CP-PC RD - Coding profile

1701967

<https://www.phoenixcontact.com/us/products/1701967>

Coding profile, for plugging into the coding ribs of the plug at a later date, insulating material, color: Red

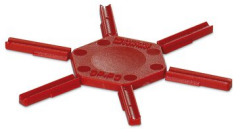

BF-PC 4 - Mounting flange

1827570

<https://www.phoenixcontact.com/us/products/1827570>

Mounting flange, is snapped onto the left and right of the headers, for screw connection with PC 4/...-STF-7.62



PC 4/ 2-G-7,62 - PCB header

1804797

<https://www.phoenixcontact.com/us/products/1804797>



POWERCOMBICON PCB-SHIELD - Accessories

1968387

<https://www.phoenixcontact.com/us/products/1968387>



Shroud, Accessories, contact surface: Tin, product range: EMV-SCHIRMUNG

PC 4/ 2-ST-7,62 - PCB connector

1804904

<https://www.phoenixcontact.com/us/products/1804904>

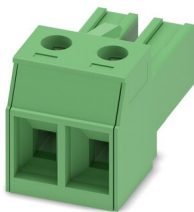

PCB connector, nominal cross section: 4 mm², color: green, nominal current: 20 A, rated voltage (III/2): 630 V, contact surface: Tin, type of contact: Socket, number of potentials: 2, number of rows: 1, number of positions: 2, number of connections: 2, product range: PC 4/..-ST, pitch: 7.62 mm, connection method: Screw connection with tension sleeve, screw head form: L Slotted, conductor/PCB connection direction: 0 °, locking clip: - Locking clip, plug-in system: COMBICON PC 4, locking: without, mounting: without, type of packaging: packed in cardboard

PC 4/ 2-G-7,62 - PCB header

1804797

<https://www.phoenixcontact.com/us/products/1804797>



PCC 4/ 2-ST-7,62 - PCB connector

1840191

<https://www.phoenixcontact.com/us/products/1840191>



PCB connector, nominal cross section: 4 mm², color: green, nominal current: 20 A, rated voltage (III/2): 1000 V, type of contact: Socket, number of potentials: 2, number of rows: 1, number of positions: 2, number of connections: 2, product range: PCC 4/...-ST, pitch: 7.62 mm, connection method: Crimp connection, conductor/PCB connection direction: 0 °, locking clip: - Locking clip, plug-in system: COMBICON PC 4, locking: without, mounting: without, type of packaging: packed in cardboard, Corresponding female crimp contacts with current [A] and conductor cross section range [mm²] data: 13,5A/STG-MTN 0,5-1,0 (3190438); 13,5A/STG-MTN 0,5-1,0 BA (3190629); 20A/STG-MTN 1,5-2,5 (3190506); 20A/STG-MTN 1,5-2,5 BA (3190632). BA = Taped contacts

Phoenix Contact 2023 © - all rights reserved

<https://www.phoenixcontact.com>

Phoenix Contact USA

586 Fulling Mill Road

Middletown, PA 17057, United States

(+717) 944-1300

info@phoenixcon.com